

NEWS **EXPRESS**

★
2ND ISSUE 2022
SEPTEMBER

PREMIERE FOR 8 BRAND-NEW MODELS!



BRAWA
A PASSION FOR DETAIL



FOR BULK CARGO AND PART LOADS. AND LOVERS OF DETAIL



Lidded Freight Car K25 DB

Road no. 341 740

Order no. **50548**



DELIVERY DATE: END OF Q4/2022

RRP* 49,90 EUR

For the transport of moisture-sensitive goods, such as lime, the railways introduced so-called "Lidded Freight Cars" in various designs from a very early stage. The freight car had the short 4 m wheel base that was typical for this period and had a maximum load of 17.5 t. In order to withstand this weight, the side panels and hinge lid were strengthened with prominent crossed beads.



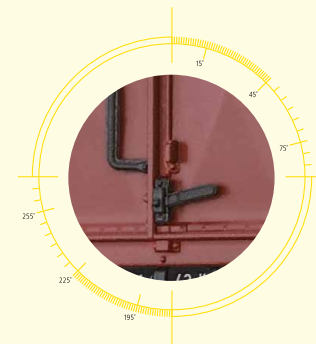

Lidded Freight Car K DR

Road no. 21-07-43

Order no. **50550**

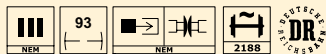

DELIVERY DATE: END OF Q4/2022

RRP* 49,90 EUR

- Fine engravings and rivets
- True-to-scale reproduction of the standardised Lidded Freight Car

- Axle holder made of metal
- Extra brake systems





LIMITED SPECIAL MODEL „CHRISTMAS 2022“: LEBKUCHEN-SCHMIDT – THE ORIGINAL FROM NUREMBERG

Nuremberg gingerbread is a world-famous specialty. They go back to Frankish monks who have been making this special pastry since the 14th century. The first known document entry of a gingerbread maker dates back to 1395. At that time, Nuremberg was an important point on various trade routes. In this way, many foreign spices such as

allspice, cloves, cardamom, nutmeg and cinnamon found their way into the city. As well as rare ingredients such as almonds. In addition, there was a well-functioning beekeeper in the nearby Lorenzer Reichswald, which also ensured the supply of honey.



E. Otto Schmidt

LEBKUCHENFABRIK AUS NÜRNBERG

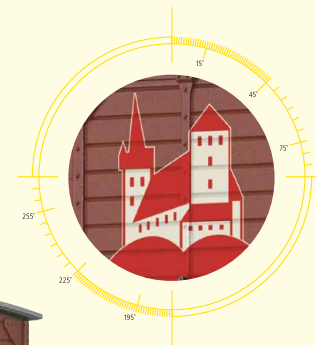

Covered Freight Car G10 „Lebkuchen-Schmidt“ DB

Road no. 125 627

Order no. **49870** RRP* 43,90 EUR

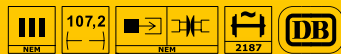

DELIVERY DATE: END OF OCTOBER 2022

- Metal axle brake frame
- Brake shoes in wheel plane
- Extra bearing collars
- Separately mounted U-profile as coach body supports
- NEM-standard short-coupling
- Tip bearing wheelsets
- Extra mounted steps
- Separately mounted brake unit on the car bottom

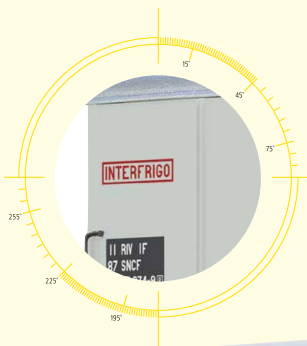
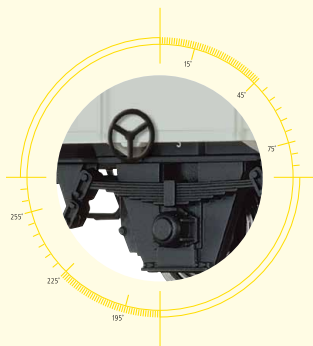

DEVIATING ROAD NO.

Refrigerator Car UIC Standard 1 „STEF” SNCF

Road no. 11 87 082 7 060-8 [P]

Order no. **48340**



135



2181



- Extra mounted steps and handrails
- Multi-part brake system in wheel plane
- Fine paintwork and printing
- Wheelsets in toe bearing

DELIVERY DATE: END OF Q4/2022

RRP* 43,90 EUR





SOON ON YOUR RAILROAD TRACKS. WITH MANY DETAILS



DEVIATING ROAD NO.

Refrigerator Car UIC Standard 1 Ibces „Transthermos Kühlverkehr“ DB

Road no. 11 80 083 0 025-3 [P]

Order no. **50025**



135



2181



DELIVERY DATE: END OF Q4/2022

RRP* 43,90 EUR



NEWS FROM BRAWA

Simply subscribe to our free BRAWA newsletter
at www.brawa.de

HO

HEIDELBERGER ZEMENT



Container Car Ucs⁹⁰⁹ „Heidelberg Zement“ DB

Road no. 44 80 910 6 107-8 [P]

Order no. **50578**

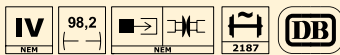

DELIVERY DATE: END OF Q4/2022

RRP* 51,90 EUR

- Brake shoes in wheel plane
- Extra mounted steps
- Separately mounted container cover and valves
- Separately mounted axle brake rod
- Extra mounted brake system
- NEM-standard close coupling





THE THINGS THAT MAKE LITTLE WORLDS BIG

It's the little things that make model railways such lovable miniature worlds. In addition to our lamps and cable railway sets, we offer a small yet selective range of perfectly replicated accessories, especially accessories for railway stations, including clocks, advertising pylons, telephone boxes, brick arches and shop arcades, plus tiny, realistic platform requisites. For experts, the accessories are far more than props.

Let yourself be inspired at www.brawa.de

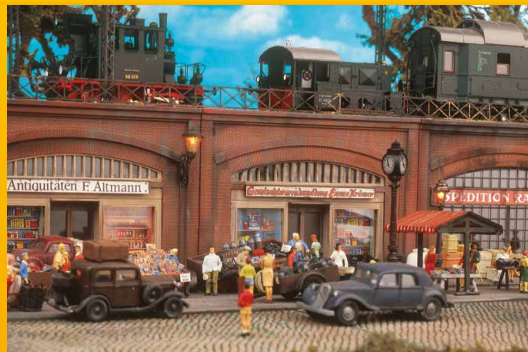



SMALL GAUGE. BIGGEST DETAILS



PICTURE SHOWS H0-MODEL

Diesel Locomotive BR 132 DR

Road no. 132 166-0

Order no. **61040**
RRP* 180,90 EUR



61041
RRP* 299,90 EUR

IV

130,1



2)



- Rear signals
- Illuminated driver's cab
- True to original sound
- True-to-original speed
- 5-pole motor
- All axles driven
- Standard shaft to NEM 355
- Reproduction of cooling van
- Finely engraved details

DELIVERY DATE: END OF Q4/2022

N



À VÔTRE SANTÉ. EXCELLENT REASONS TO CELEBRATE







PICTURE SHOWS H0-MODEL



Covered Freight Car Kuwf „Champagne Mercier“ A.L.

Road no. 500.390

| | | | | | |
|------------------------|---|---|---|---|-------------|
| Order no. 67499 |  |  |  |  | A.L. |
|------------------------|---|---|---|---|-------------|

DELIVERY DATE: END OF Q4/2022

RRP* 40,90 EUR

- With disk wheel sets (deviating picture)
- Metal wheels
- Finely engraved board joints and ventilators
- True-to-original frame body
- Finest paintwork and printing
- True-to-original replica of the brake unit on the car bottom
- NEM-standard short-coupling





COMFORTABLE SERVICE AT THE BRAWA WEBSITE

ORDERING SPARE PARTS

www.brawa.de/spareparts

FAQ - FREQUENTLY ASKED QUESTIONS

www.brawa.de/faq

WWW.BRAWA.DE

*Recommended retail price (incl. 19 % VAT), prices are subject to change.

Product modifications are possible after this brochure is printed. Subject to modifications in design and shape. Colour deviations are possible.

Champagne Mercier, Heidelberger Zement, Lebkuchen-Schmidt and Transthermos Kühlverkehr are registered trademarks.

BRAWA Artur Braun Modellspielwarenfabrik GmbH & Co. KG Uferstraße 24–30 D-73630 Remshalden

Hotline: Monday – Thursday 1 p.m. to 3 p.m. +49 7151 97935-68

Fax +49 7151 74662 info@brawa.de www.brawa.de

